

- NOTES:
- SIZE: RD-3'0"X2'6"
- 1) 40psf COVER LIVE LOAD RATING
  - 2) MILL FINISH
  - 3) MATERIALS:
    - .090 ALUMINUM, COVER
    - .090 ALUMINUM, CURB
    - .090 ALUMINUM, COUNTER FLASHING
    - .063 ALUMINUM, COVER LINER
    - .063 ALUMINUM, CURB LINER

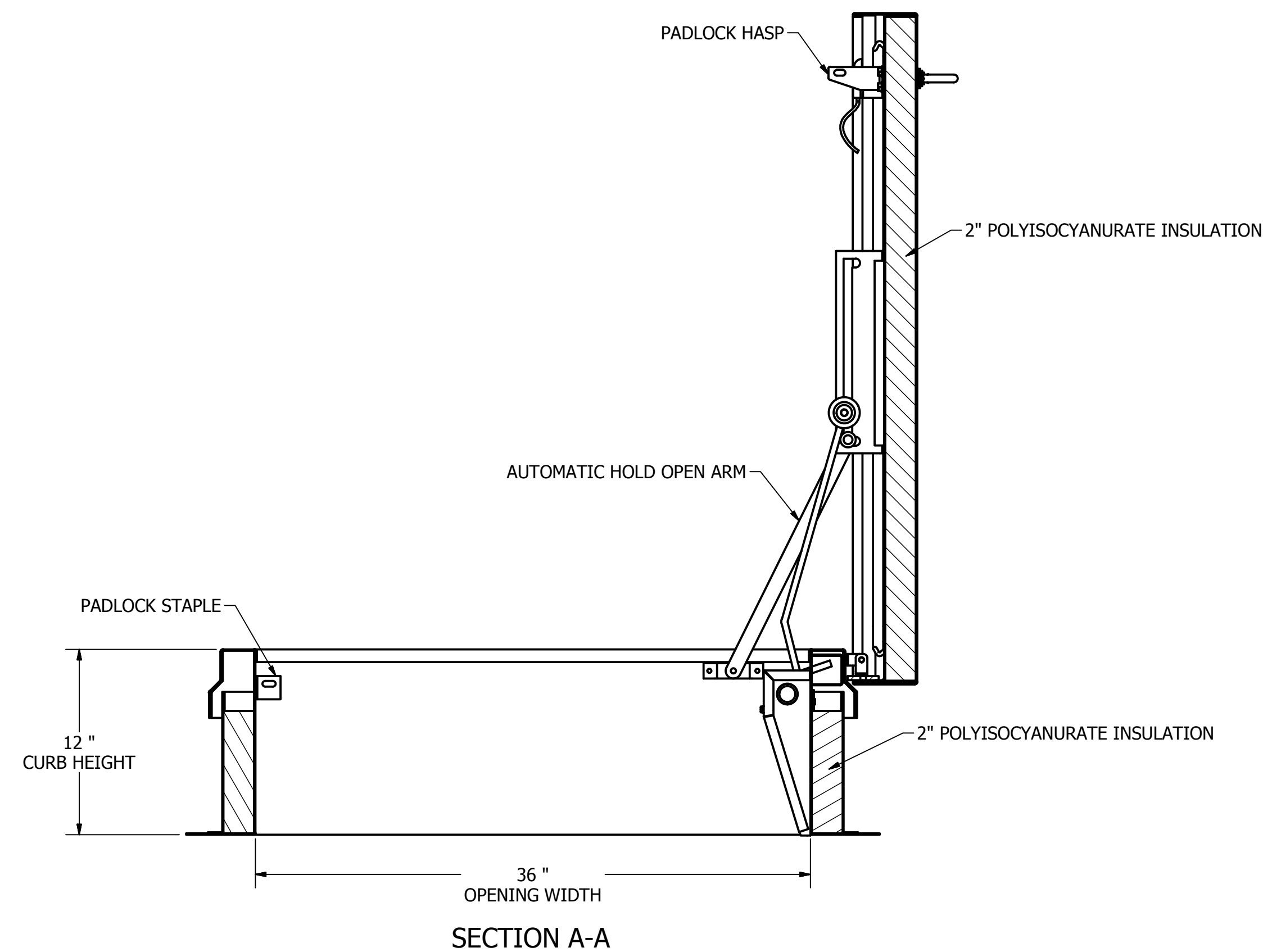
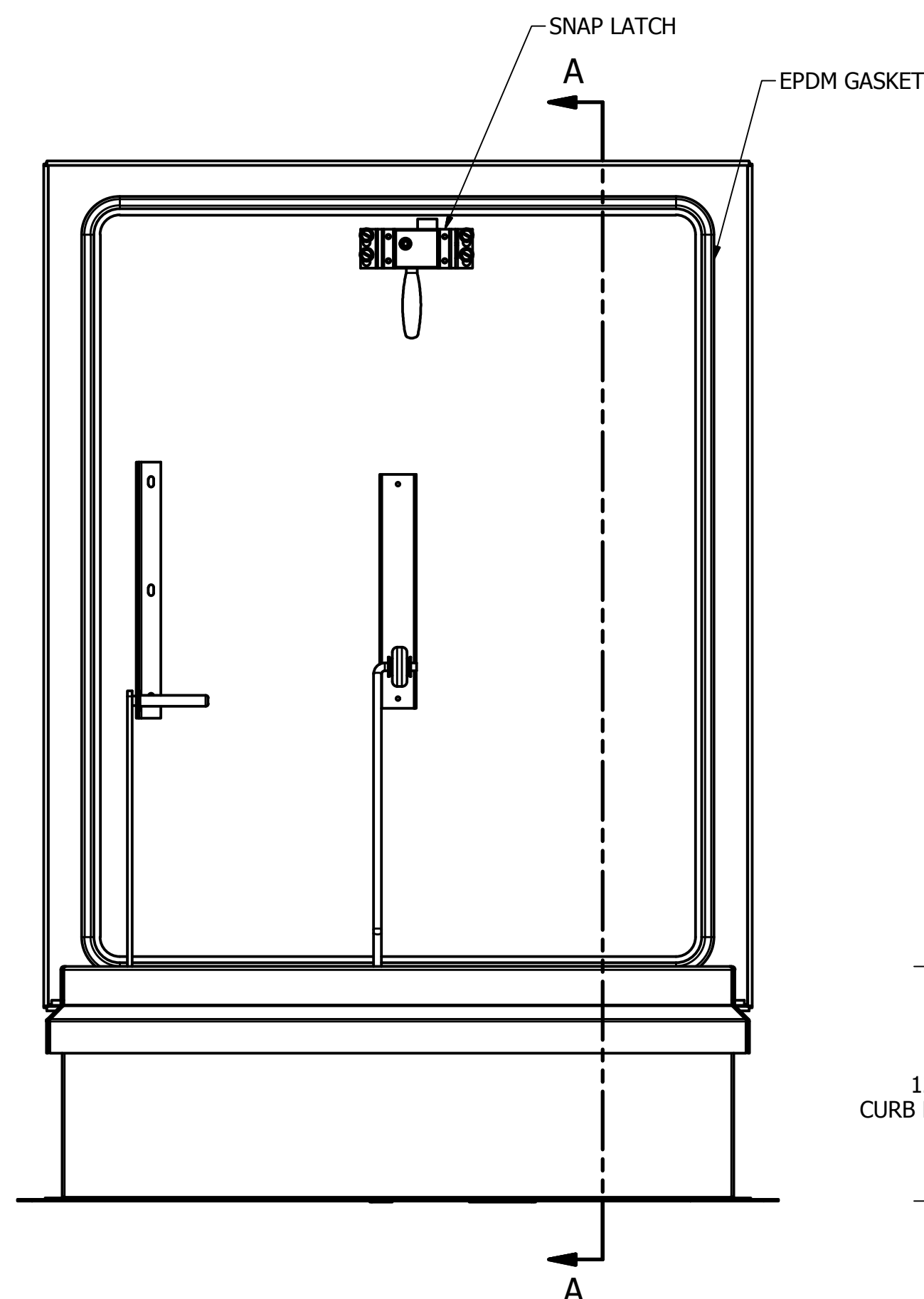

ORDER WILL NOT BE RELEASED FOR FABRICATION UNTIL SIGNED COPY IS RECEIVED.

VERIFICATION AND APPROVAL OF GENERAL ARRANGEMENT AND OVERALL DIMENSIONS FOR THIS DOCUMENT ARE REQUIRED BEFORE THE ORDER IS ENTERED FOR MANUFACTURING.

APPROVAL SIGNATURE \_\_\_\_\_

TITLE HELD \_\_\_\_\_

DATE OF APPROVAL \_\_\_\_\_

DRAWN	CMD	2/27/2015	TITLE	
CHECKED	<b>MILCOR</b>		RD-1 EE SINGLE LEAF ROOF HATCH	
QA	TOLERANCE UNLESS SPECIFIED		SIZE	DWG NO
MFG	.XXX ± 0.005"		D	3501-132-9EE
APPROVED	.XX ± 0.01"		SCALE	REV
	FRACT. ± 1/16"			--
	ANGLES ± 1'		SHEET 1 OF 1	